

# 产品规格书

## Product Specification Report

客户名称 (Customer Name):					
客户料号 (Customer NO.):					
产品名称 (Product Name):			2835 系列 LED 贴片灯		
产品型号 (Product Type):			YKIR2835-730NM-0.2W		
制定日期 (Date Prepared):			2019-05-26		
<b>源科光电确认</b>			<b>客户确认</b>		
YNKE Approval			Customer's Approval		
制定	核准	业务部	确认人	核准	采购部
Development	Approved	Marketing Dept	Confirmed by	Approved	Purchasing Dept
<b>结果判定</b> <b>Judge outcome</b>			<b>结果判定</b> <b>Judge outcome</b>		

注: 1.此规格书以中英文方式书写,若有冲突以中文版本为准文本.

2.此规格书的最终解释权归深圳源科光电有限公司

3.此规格书的有效期限为两年,自盖章或签字之日起计算,期满时双方可以续签协议,但应采用书面形式

电 话: 0755-27167848  
TEL: 0755-27167848  
传 真: 0755-27167816  
Fax: 0755-27167816

公司网址: <http://www.ykgdled.com/>  
Web : <http://www.ykgdled.com/>  
地 址: 广东省深圳市光明新区公明合水口第二工业区 19 栋 3 楼  
Add: 广东省深圳市光明新区公明合水口第二工业区 19 栋 3 楼

# SURFACE MOUNT LED LAMPS

## 2835 系列 LED 贴片灯

产品型号 (Product Type): YKIR2835-730NM-0.2W

### Package Dimensions (封装尺寸)

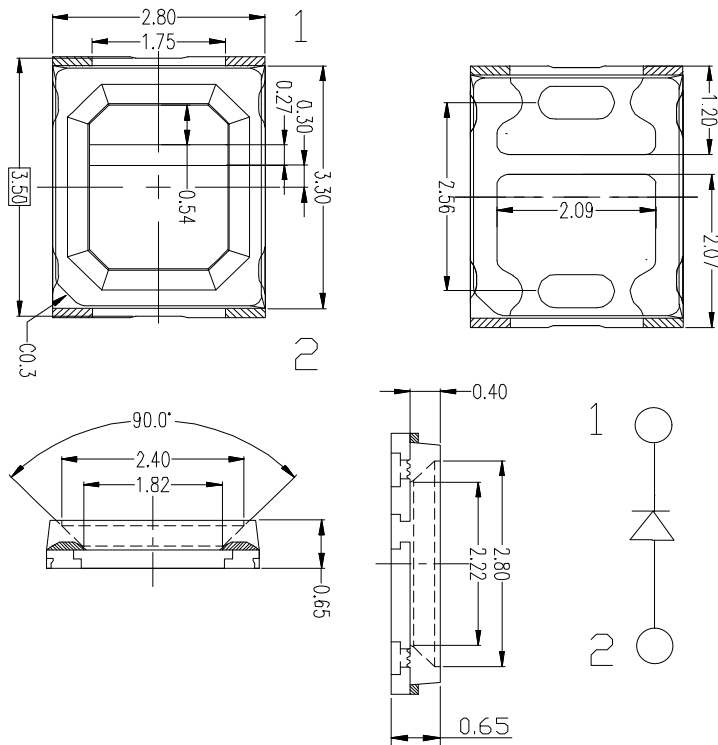

### Recommended Soldering Patter (n 推荐焊盘式样)

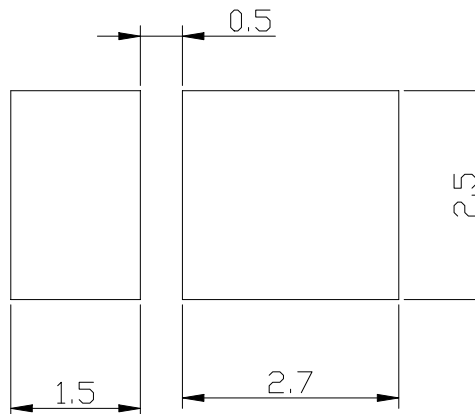

### 备注 (NOTES):

- 所有尺寸单位为毫米  
All dimensions are in millimeters
- 如无其他备注, 尺寸公差为±0.1mm  
Tolerances are ±0.1mm unless otherwise note.

## SURFACE MOUNT LED LAMPS

**产品型号 (Product Type): YKIR2835-730NM-0.2W**

### 极限参数 Absolute maximum ratings (Ta=25°C)

参数 Parameter	符号 Symbol	数值 Value	单位 Unit
正向电流 Forward current	If	60	mA
反向耐压 Reverse voltage	Vr	5	V
耗散功率 Power dissipation	Pd	96	mW
工作环境温度 Operating temperature range	Top	-25~+80	°C
贮藏温度 Storage temperature range	Tstg	-30~+85	°C
峰值脉冲电流 Peak pulsing current (1/8 duty f=1KHz)	Ifp	78	mA
结温 Junction Temperature	Tj	115	°C/W
静电 Electrostatic Discharge(HBM)	ESD	1500	V

### 光电特性 Electro-Optical characteristics (TA=25°C)

参数 Parameter	测试条件 Test Condition	符号 Symbol	颜色	数值 Value			单位 Unit
				Min	Typ	Max	
色温 Color Temperature	If=60mA	CCT	--	--	--	--	K
正向电压 Forward voltage	If=60mA	Vf	IR	1.8	--	2.2	V
发射功率 Total Radiated Power	If=60mA	φ	IR	40	--	60	mW
视角 Viewing angle at 50% IV	If=60mA	2θ1/2	IR	--	120	--	Deg
主波长 Dominant wavelength	If=60mA	λd	IR	730	--	740	nm
反向电流 Reverse current	Vr=5V	Ir	IR	--	5	--	μA
显色性指数 Color Rendering Index	If=60mA	CRI	--	--	--	--	Ra

# SURFACE MOUNT LED LAMPS

产品型号 (Product Type): YKIR2835-730NM-0.2W

典型的光电特性曲线图表 Typical photo-electricity characteristic curve chart

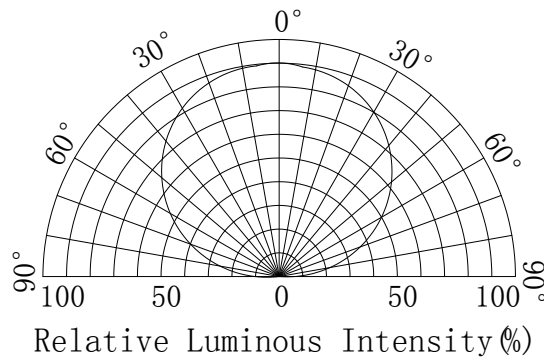
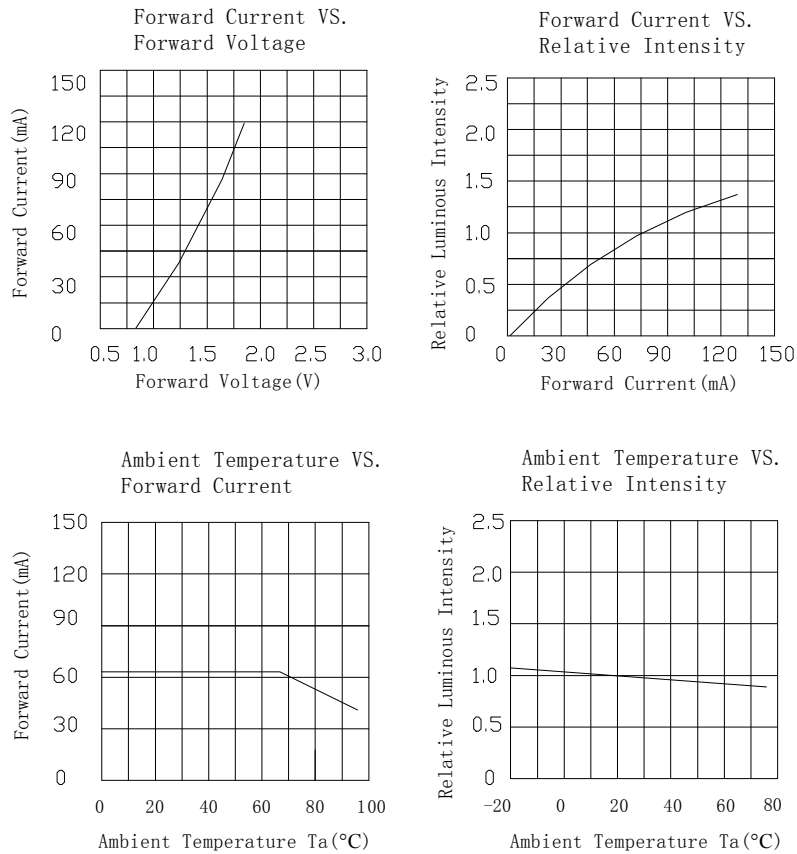

# SURFACE MOUNT LED LAMPS

产品型号 (Product Type): YKIR2835-730NM-0.2W

典型的光电特性曲线图表 Typical photo-electricity characteristic curve chart

CIE 1931 xy CHROMATICITY DIAGRAM

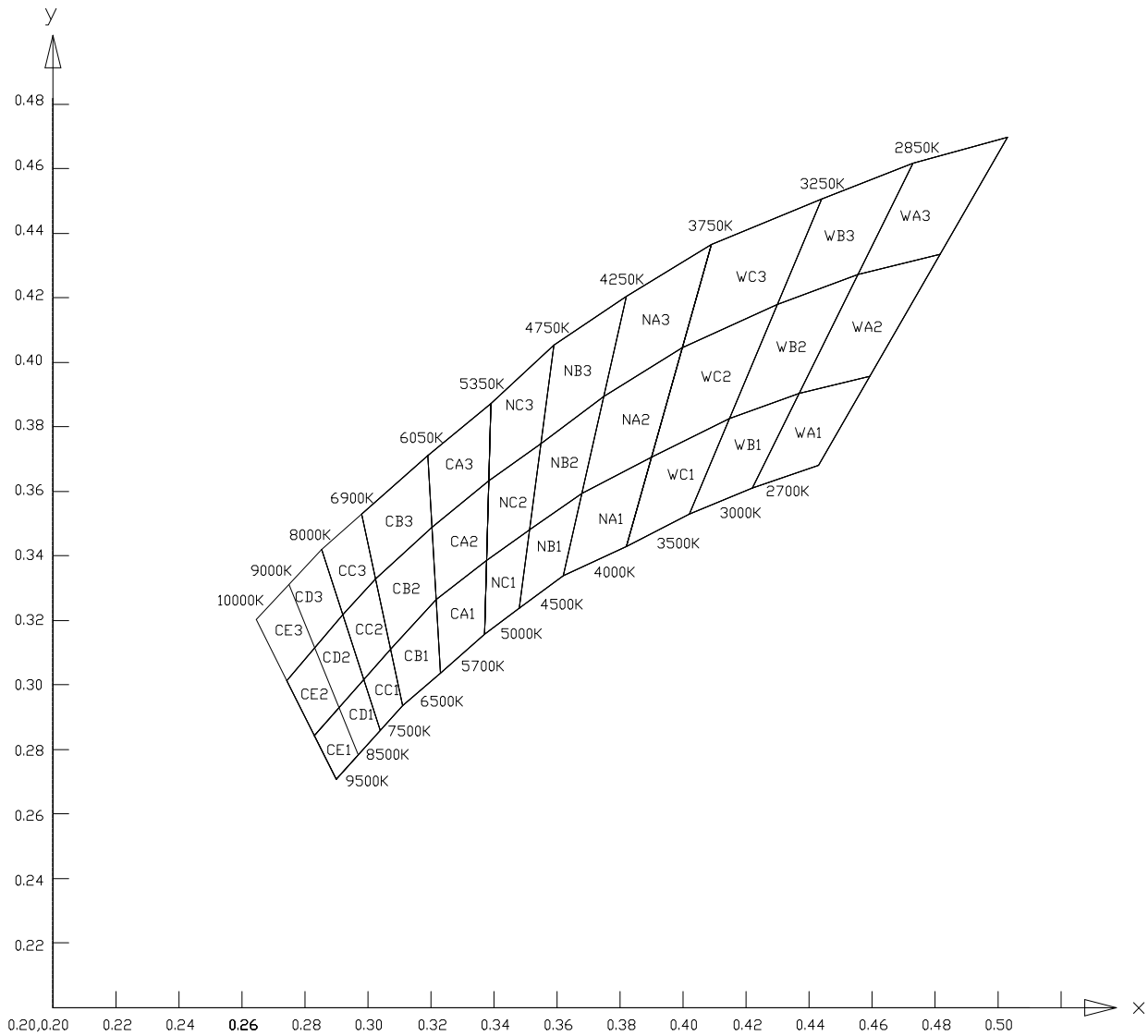

## SURFACE MOUNT LED LAMPS

### 可靠性实验项目 Test items and results of reliability

类别 Type	测试项目 Test item	源科参照标准 YK. Standard	测试条件 Test Conditions	备注 Note	数量 Quantity	不良数量 Number of Damaged
Environmental Sequence	高低温循环 Temperature Cycle	JIS C 7021 (1977)A-4	-25°C 30min ↑↓5min 80°C 30min	100 cycle	22	0
	热冲击 Thermal Shock	MIL-SLD-107D	-25°C 15min ↑↓5min 80°C 15min	50cycle	22	0
	高湿度热循环 High Humidity Heat Cycle	JIS C 7021 (1977)A-5	30°C (<=) 65°C 90%RH 24hrs/1cycle	10 cycle	22	0
	高温存储 High Temperature Storage	JIS C 7021 (1977)B-10	T <sub>a</sub> =80°C	1000hrs	22	0
	高温高湿存储 Humidity Heat Storage	JIS C 7021 (1977)B-11	T <sub>a</sub> =60°C RH=90%	1000hrs	22	0
	低温存储 Low Temperature Storage	JIS C 7021 (1977)B-12	T <sub>a</sub> =-30°C	1000hrs	22	0
Operation Sequence	常温寿命测试 Life Test	JIS C 7035 (1985)	T <sub>a</sub> =25°C I <sub>F</sub> =60mA	1000hrs	22	0
	高温高湿寿命测试 High Humidity Heat Life Test	☞	60°C RH=90% I <sub>F</sub> =60mA	500hrs	22	0
	低温寿命测试 Low Temperature Life Test	☞	T <sub>a</sub> =-25°C I <sub>F</sub> =60mA	1000hrs	22	0

☞请参考可靠性测试标准规范。Refer to reliability test standard specification for in this line.

### 失效判定标准 Criteria For Judging Damage

测试项目	符号	测试条件	判定标准
正向电压 Forward Voltage	V <sub>F</sub>	I <sub>F</sub> =I <sub>FT</sub>	初始值±10% Initial Data±10%
反向电流 Reverse Current	I <sub>R</sub>	V <sub>R</sub> =5V	I <sub>R</sub> ≤ 10μA
光强 Luminous Intensity	I <sub>V</sub>	I <sub>F</sub> =I <sub>FT</sub>	平均 I <sub>V</sub> 衰减 ≤ 30%，单个平均 I <sub>V</sub> 衰减 ≤ 50% Average I <sub>V</sub> degradation ≤ 30% Single LED I <sub>V</sub> degradation ≤ 50%
耐焊接热 Resistance to Soldering Heat	--	--	材料无内部裂痕、无材料间爆裂、剥离、无死灯 Material without internal cracks, no material between stripped, no dead light.

\*数据工作表中所示的技术信息仅限于典型特征和电路实例引用的产品。它既不构成工业特性的保证,也不构成任何许可的授权

The technical information shown in the data sheets are limited to the typical characteristics and circuit examples of the referenced products. It does not constitute the warranting of industrial property nor the granting of any license.

# SURFACE MOUNT LED LAMPS

产品型号 (Product Type): YKIR2835-730NM-0.2W

## 焊接指导 Guideline for Soldering

1、回流焊接：推荐以下无铅回流焊接温度图进行。

**Reflow Soldering:** Use the conditions shown in the under Figure of Pb-Free Reflow Soldering.

SMD-Reflow Soldering Profile for lead free soldering( Acc.to J-STD-020B)

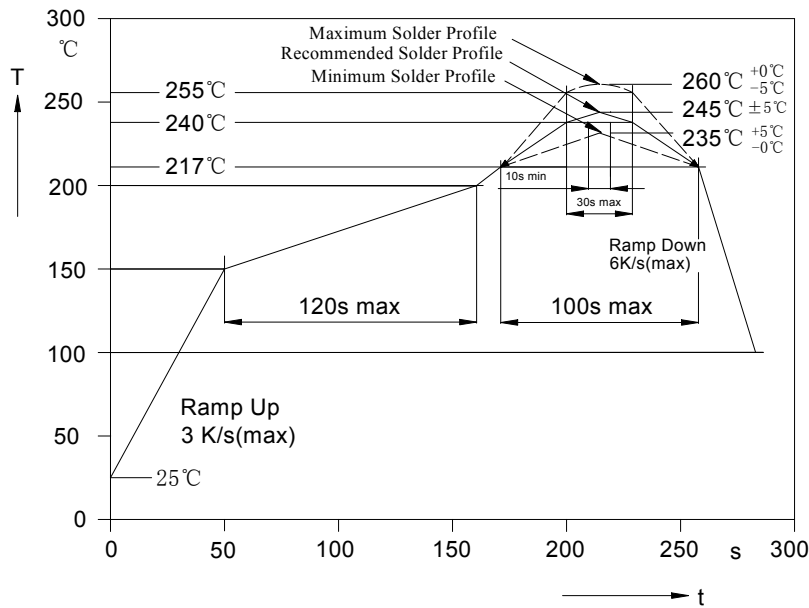

**Remark:** If not lead free soldering, the recommended solder profile is 230°C and max solder profile is 245°C.

## 2、使用烙铁人手焊接 Hand Soldering

1)、推荐使用低功率于 20W 的烙铁，焊接时烙铁的温度必须保持在 360°C 以下，且每个电极只能进行一次焊接，每次焊接的持续时间不得超过 3 秒。

A soldering iron of less than 20W is recommended to be used in Hand Soldering Please keep the temperature of the soldering iron under 360°C while soldering Each terminal of the LED is to go for less than 3 second and for onetime only.

2)、人手焊接过程中的不慎操作易引起 LED 产品的损坏，应当小心谨慎。

Be careful because the damage of the product is often started at the time of the hand soldering.

## 3、清洗 Cleaning

1)、在焊接后推荐使用酒精进行清洗，在温度不高于 30°C 的条件下持续 3 分钟，不高于 50°C 的条件下持续 30 秒，使用其他类似溶剂清洗前，请先确认使用的溶剂不会对 LED 的封装和环氧树脂造成损伤。

It is recommended that alcohol be used as a solvent for cleaning after soldering. Cleaning is to go under 30°C for 3 minutes or 50°C for 30 seconds. When using other solvents, it should be confirmed beforehand whether the solvents will dissolve the package and the resin or not.

2)、超声波清洗也是有效的方法，一般最大功率不应超过 300W，否则可能对 LED 造成损伤，请根据具体的情况预先测试清洗条件是否会对 LED 造成损伤。

Ultrasonic cleaning is also an effective way for cleaning. But the influence of Ultrasonic cleaning on LED depends on factors such an ultrasonic power. Generally, the ultrasonic power should not be higher than 300W. Before cleaning, a pre-test should be done to confirm whether any damage to LEDs will occur.

# SURFACE MOUNT LED LAMPS

产品型号 (Product Type): YKIR2835-730NM-0.2W

## 编带和包装 Tape and Packaging

### 1、带盘 Tape leader and reel

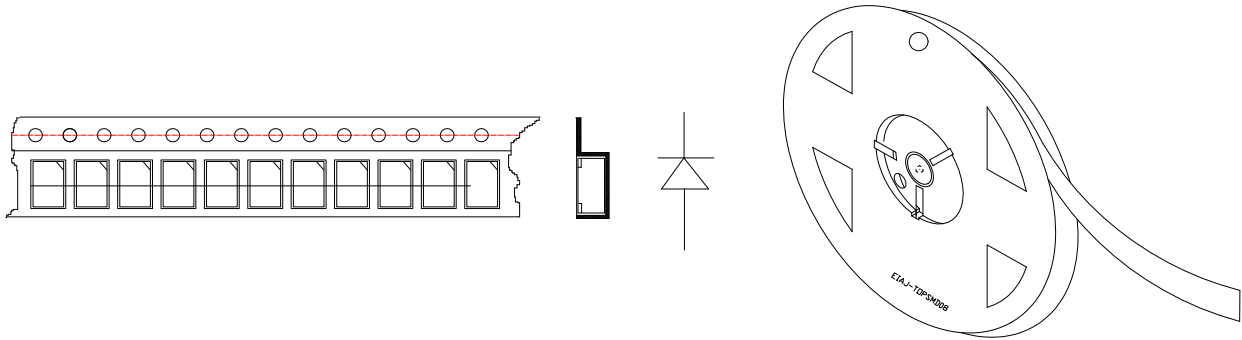

### 2、防潮袋包装 Moisture Resistant Packaging

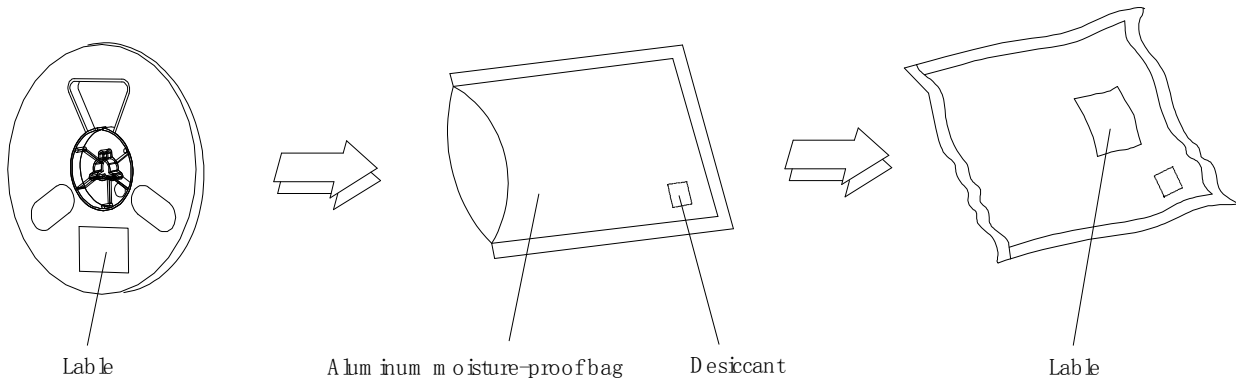

### 3、注意事项 Cautions

1)、LED 封装为硅胶，故 LED 胶体表面较软，用力按压胶体表面会影响 LED 可靠性，因此应有预防措施避免在封装的零件上的强大压力，当使用吸嘴时，胶体表面的压力应是恰当的。

The encapsulated material of the LEDs is silicone. Therefore the LEDs have a soft surface on the top of package. The pressure to the top surface will be influence to the reliability of the LEDs. Precautions should be taken to avoid the strong pressure on the encapsulated part. So when use the picking up nozzle, the pressure on the silicone resin should be proper.

2)、SMD 吸嘴的外径不应超过 LED 的尺寸以避免漏气。吸嘴的内径应尽可能大。吸嘴头建议使用柔软的材料以避免 LED 硅胶表面划伤或损坏。

The outer diameter of the SMD pickup nozzle should not exceed the size of the LED to prevent air leaks. The inner diameter of the nozzle should be as large as possible. pliable material is suggested for the nozzle tip to avoid scratching or damaging the LED surface during pickup.

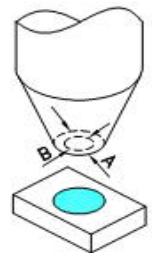



# SURFACE MOUNT LED LAMPS

产品型号 (Product Type): YKIR2835-730NM-0.2W

## 处理防备措施 Handling Precautions

- 1、 通过使用适当的工具从材料侧面夹取，不可直接用手或尖锐金属压胶体表面，它可能会损坏内部电路。  
Handle the component along the side surface by using forceps or appropriate tools; do not directly touch or  
Handle the  
silicone lens surface, it may damage the internal circuitry.

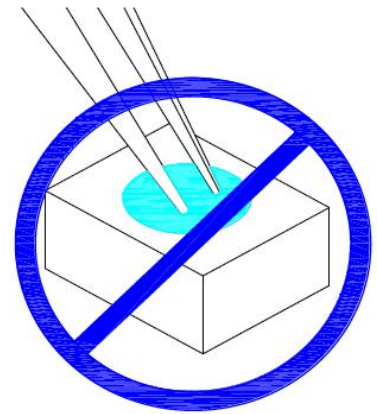
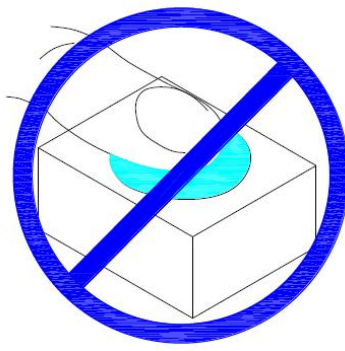
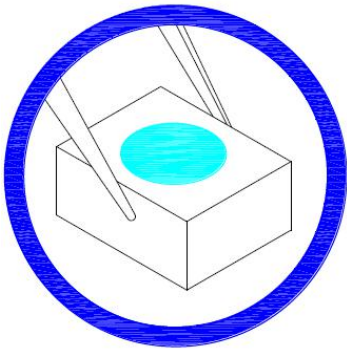

- 2、 不可将模组材料堆积在一起，它可能会损坏内部电路  
Do not stack together assembled PCBs containing LEDs.  
PH<7  
Impact may scratch the silicone lens or damage the internal  
circuitry

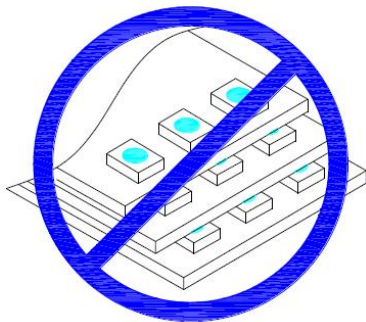

- 3、 不可用在 PH<7 的酸性场所  
Not suitable to operate in acidic envi-ronment,

